

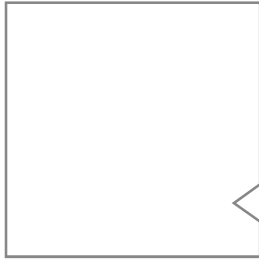

CLEAN WATER GROUP





**FLECK**  
Pentair Water

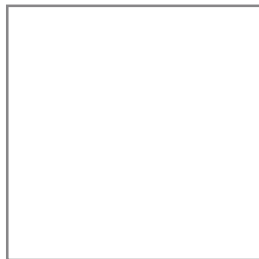
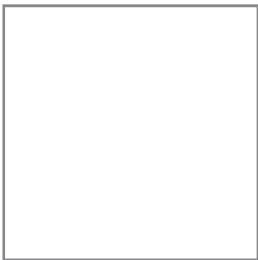

*Application date 01/01/2010*



# Table of contents



<b>Fleck Valves</b>	
4600 Valve .....	<b>4</b>
5600 Valve .....	<b>5</b>
5665 Valve .....	<b>5</b>
5600 SE Electronic Valve .....	<b>6</b>
5600 SXT Electronic Valve .....	<b>6</b>
5000 SXT Electronic Valve.....	<b>5</b>
6600 Valve .....	<b>7</b>
6665 Valve .....	<b>7</b>
6700 Valve .....	<b>8</b>
6765 Valve .....	<b>8</b>
7700 Valve .....	<b>9</b>
9000 Valve .....	<b>10</b>
9000/6 Valve .....	<b>10</b>
9100 Valve .....	<b>11</b>
9500 Valve .....	<b>12</b>
2510 Valve .....	<b>13</b>
2750 Valve .....	<b>14</b>
2850 Valve .....	<b>15</b>
2910 Valve .....	<b>16</b>
3150 Valve .....	<b>17</b>
3900 Valve .....	<b>18</b>
<b>Options For Commercial/Industrial Valve</b> .....	<b>19</b>
<b>Remote Meters</b> .....	<b>20</b>
<b>NXT Meter &amp; Meter Cables</b> .....	<b>21</b>
<b>Accessories</b>	
Yokes / By-pass / Safety Brine Valve / Air Checks .....	<b>22</b>
Distributors / Others / Side Mount Adapters .....	<b>24</b>
<b>Valve Prices Include &amp; Valve Description</b> .....	<b>26</b>
<b>Deductions</b> .....	<b>31</b>
<b>Fleck Spare Parts</b> .....	<b>33</b>
<b>Fleck Products - General Warranty</b> .....	<b>78</b>
<b>Warranty conditions for Pentair Water Europe products</b> .....	<b>81</b>

# 4600 Valve

Packing Quantity 6

## Base Valve

4600 / 1600 Timeclock Mechanical

## Timer Choice

SXT Timer

## Meter Choices

3/4" Meter - 8 m<sup>3</sup>

3/4" Meter - 40 m<sup>3</sup>

3/8" Meter - 3,2 m<sup>3</sup>

3/4" Meter - Electronic



## Options

Fast Regeneration for tanks up to 10" (35 l. resin)

Mechanical Immediate Regeneration including microswitch not wired

Auxiliary Microswitch not wired

24 V / 50 Hz w/o transformer, with power cord, w/o plug

24 V / 50 Hz with transformer 230-24 V / 50/60 Hz 10 VA

PVC Injector (for Potassium Permanganate) only with system 1600

LWU Piston (Low Water Usage)

Filter (without mixing, brine valve, injector / with plug)

(sans mixing, vanne à saumure, ni injecteur/avec bouchon) - (Ohne Verschneidung, Solesystem, ohne Injektor/mit Stopfen) - (senza mixing, valvola salamoia, eiettore/con tapo) - (Sin mixing, válvula de salmuera, sin eyector/con un tapón)

Filter

No mixing

No Brine Valve

Hot Water Timeclock (packed individually) up to 82° C

Hot Water 3/4" with EcoByPass (packed individually) up to 65° C - (except electronic version)

Hot water valves and their options include all internal hot water resistant parts.

Les vannes Eau Chaude et leurs options comprennent toutes les pièces internes adaptées à cet usage. - Die Heißwasser Ventile und deren Optionen enthalten alle internen Heißwasser beständigen Teile. - Le valvole per acqua calda e le loro opzioni comprendono tutti i particolari interni adattati per questo impiego. - Válvulas y sus partes internas resistentes al agua caliente.

## Complete Valves Prices - Examples

4600 / 1600 3/4" Meter 8 m<sup>3</sup>

4600 / 1600 Hot Water 3/4" Meter 8 m<sup>3</sup>



## 5600 Valve

Packing Quantity 6

### Base Valve

5600 / 1600 Timeclock Mechanical

### Meter Choices

3/4" Meter - 8 m<sup>3</sup>

3/4" Meter - 40 m<sup>3</sup>

3/8" Meter - 3,2 m<sup>3</sup>

### Options

Fast Regeneration	for tanks up to 10" (35 l. resin)
Mechanical Immediate Regeneration	including microswitch not wired
Up Flow regeneration (packed by 4)	already included whith IMM regeneration
Auxiliary Microswitch not wired	
24 V / 50 Hz	w/o transformer, with power cord, w/o plug
24 V / 50 Hz	with transformer 230-24 V / 50/60 Hz 10 VA
PVC Injector (for Potassium Permanganate)	only with system 1600
LWU Piston (Low Water Usage)	

Filter *(without mixing, brine valve, injector / with plug)*

*(sans mixing, vanne à saumure, ni injecteur / avec bouchon) - (Ohne Verschneidung, Solesystem, ohne Injektor / mit Stopfen) - (senza mixing, valvola salamoia, eiettore / con tapo) - (Sin mixing, válvula de salmuera, sin eyector / con un tapón)*

Filter

No mixing

No Brine Valve



### Complete Valves Prices - Examples

5600 / 1600 Timeclock Fast Regeneration

5600 / 1600 Immediate Regeneration 3/4" Meter 40 m<sup>3</sup>

## 5665 Valve

Packing Quantity 3

### Base Valve

5665 / 1600 Timeclock

### Meter Choices

3/4" Meter - 8 m<sup>3</sup>

3/4" Meter - 40 m<sup>3</sup>

### Options

Mechanical Immediate Regeneration

### Complete Valves Prices - Example

5665 / 1600 3/4" Meter 8 m<sup>3</sup>



## 5600 SE Electronic Valve

Packing Quantity 6

### Base Valve

5600 / 1600 SE Timeclock

### Meter Choice

¾" Meter Turbine - Electronic

### Options

Up Flow regeneration (packed by 4)

Auxiliary Microswitch not wired

Double Backwash Cam (light blue)

PVC Injector (for Potassium Permanganate) only with system 1600

Filter *(without mixing, brine valve, injector / with plug)*  
*(sans mixing, vanne à saumure, ni injecteur / avec bouchon) - (Ohne Verschneidung, Solesystem, ohne Injektor / mit Stopfen) - (senza mixing, valvola salamoia, elettore / con tapo) - (Sin mixing, válvula de salmuera, sin eyector / con un tapón)*

Filter

No mixing

No Brine Valve

### Complete Valves Prices - Example

5600 / 1600 SE ¾" Meter



## 5600 SXT Electronic Valve

Packing Quantity 6

### Base Valve

5600 / 1600 SXT Timeclock

### Meter Choice

¾" Meter Turbine - Electronic

### Options

Up Flow regeneration (packed by 4)

Auxiliary Microswitch not wired

Double Backwash Cam (light blue)

PVC Injector (for Potassium Permanganate) only with system 1600

Filter *(without mixing, brine valve, injector / with plug)*  
*(sans mixing, vanne à saumure, ni injecteur / avec bouchon) - (Ohne Verschneidung, Solesystem, ohne Injektor / mit Stopfen) - (senza mixing, valvola salamoia, elettore / con tapo) - (Sin mixing, válvula de salmuera, sin eyector / con un tapón)*

Filter

No mixing

No Brine Valve

### Complete Valves Prices - Example

5600 / 1600 SXT ¾" Meter



## 5000 SXT Electronic Valve

Packing Quantity 6

### Base Valve

5000 / 1600 SXT Timeclock

### Meter Choice

¾" Meter Turbine - Electronic

### Options

Up Flow regeneration

Auxiliary Microswitch not wired

DLFC > 7 GPM (8, 9, 10, 12, 15 GPM)

1" Brass & reducer bushing

Filter - always Up Flow

*(without mixing, brine valve, injector / with plug) - (sans mixing, vanne à saumure, ni injecteur/avec bouchon) - (Ohne Verschneidung, Solesystem, ohne Injektor/mit Stopfen) - (senza mixing, valvola salamoia, eiettore/con tapo) - (Sin mixing, válvula de salmuera, sin eyector/con un tapón)*

Filter

No mixing

No Brine Valve



### Complete Valves Prices - Example

5000 / 1600 SXT ¾" Meter

## 6600 Valve

Packing Quantity 4

### Base Valve

6600 / 1600 Timeclock

### Meter Choice

¾" Meter - Electronic

### Options

Up Flow regeneration

Variable brining

always with Up Flow

Auxiliary Microswitch not wired

PVC Injector (for Potassium Permanganate)

only with system 1600

### Complete Valves Prices - Example

6600 / 1600 ¾" Meter Up Flow Variable brining



## 6665 Valve

Packing Quantity 3

### Base Valve

6665 / 1600 ¾" Meter Electronic



## 6700 Valve

Packing Quantity 4

### Base Valve

6700 / 1600 Timeclock Mechanical

### Meter Choice

¾" Meter - Electronic

### Options

Up Flow regeneration

Variable brining always with Up Flow Metered

Auxiliary Microswitch not wired

PVC Injector (for Potassium Permanganate) only with system 1600

### Complete Valves Prices - Example

6700 / 1600 ¾" Meter Up Flow Variable brining



## 6765 Valve

Packing Quantity 3

### Base Valve

6765 / 1600 ¾" Meter Electronic



# 7700 Valve

Packing Quantity 1

## Base Valve

7700 / 1600 SXT Timeclock

## Meter Choice

1 1/4" Integral Meter - Electronic

## Options

High Flow

Filter *(without mixing, brine valve, injector / with plug)*

*(sans mixing, vanne à saumure, ni injecteur/avec bouchon) - (Ohne Verschneidung, Solesystem, ohne Injektor/mit Stopfen) - (senza mixing, valvola salamoia, eiettore/con tapo) - (Sin mixing, válvula de salmuera, sin eyector/con un tapón)*

Filter (microswitch included)

No Brine Valve

Injector # 4

Injector # 5

## Complete Valves Prices - Examples

7700 / 1600 SXT Integral Meter

7700 / 1600 SXT Integral Meter High Flow

7700 / - Filter



## 9000 Valve

Packing Quantity 1

### Base Valve

9000 / 1600 ¾" Meter 8 m³ Mechanical

### Timer Choices

SXT Timer

ET Timer



### Meter Choices

¾" Meter - 40 m³	Plastic
¾" Meter - Electronic	Plastic
1" Meter - 20 m³	Brass
1" Meter - 100 m³	Brass
1" Meter - Electronic with "ET" ONLY	Brass with plastic cover

### Options

Up Flow regeneration

Auxiliary Microswitch not wired

Auxiliary Microswitch wired included with ET

Hot Water ¾" EcoByPass up to 65° C - (except electronic version)

Hot Water 1" Meter up to 65° C - (except electronic version)

*Hot water valves and their options include all internal hot water resistant parts.*

*Les vannes Eau Chaude et leurs options comprennent toutes les pièces internes adaptées à cet usage. - Die Heißwasser Ventile und deren Optionen enthalten alle internen Heißwasser beständigen Teile. - Le valvole per acqua calda e le loro opzioni comprendono tutti i particolari interni adattati per questo impiego. - Válvulas y sus partes internas resistentes al agua caliente.*

### Complete Valves Prices - Examples

9000 / 1600 SXT ¾" Meter

9000 / 1600 ET 1" Brass Meter

## 9000/6 Valve

Packing Quantity 1

### Base Valve

9000 / 6 / 1600 SXT ¾" Meter



# 9100 Valve

Packing Quantity 1

## Base Valve

9100 / 1600 ¾" Meter 8 m³ Mechanical

## Timer Choices

SXT Timer

ET Timer



## Meter Choices

¾" Meter - 40 m³	Plastic
¾" Meter - Electronic	Plastic
1" Meter - 20 m³	Brass
1" Meter - 100 m³	Brass
1" Meter - Electronic with "ET" ONLY	Brass with plastic cover

## Options

Mixing

Up Flow regeneration

Auxiliary Microswitch not wired

Auxiliary Microswitch wired included with ET

## Complete Valves Prices - Examples

9100 / 1600 1" Meter 20 m³

9100 / 1600 ET 1" Brass Meter

# 9500 Valve

Packing Quantity 1

## Base Valve

9500 / 1600 1" Meter 20 m<sup>3</sup> Mechanical

Kit copper tubes 2<sup>nd</sup> tank adapter sold separately as accessories

## Timer Choices

SXT Timer

ET Timer

## Meter Choices

1" Meter - 100 m <sup>3</sup>	Brass
1" Meter - Electronic	Brass with plastic cover
1 ½" Meter - 40 m <sup>3</sup>	Brass
1 ½" Meter - 200 m <sup>3</sup>	Brass
1 ½" Meter - Electronic	Brass with plastic cover
1 ½" InLine Meter - Electronic	Plastic

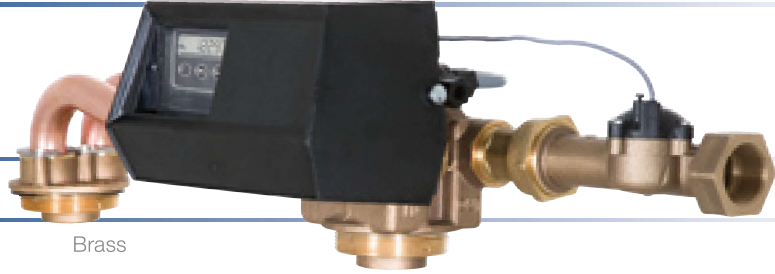

## Options

Brine Valve 1710

Auxiliary Microswitch not wired

Auxiliary Microswitch wired included with ET

Hot Water 1" & 1 ½" Meter up to 65° C - (except electronic version)

*Hot water valves with 1700 BV and their options include all internal hot water resistant parts.*

*Les vannes Eau Chaude avec BV 1700 et leurs options comprennent toutes les pièces internes adaptées à cet usage. - Die Heißwasser Ventile mit 1700 Soleventile und deren Optionen enthalten alle internen Heißwasser beständigen Teile. - Le valvole per acqua calda con valvola salamoia 1700 e le loro opzioni comprendono tutti i particolari interni adattati per questo impiego. - Válvulas con válvula de salmuera 1700 y sus partes internas resistentes al agua caliente.*

## Complete Valves Prices - Examples

9500 / 1600 / 1 ½" Meter 40 m<sup>3</sup>

9500 / 1710 SXT 1 ½" Meter

# 2510 Valve

Packing Quantity 1

## Base Valve

2510 / 1650 Timeclock Mechanical

## Timer Choices

MANUAL / FILTER

MANUAL / FLOAT

SXT Timer

ET Timer



## Meter Choices

3/4" Meter - 8 m<sup>3</sup> Plastic

3/4" Meter - 40 m<sup>3</sup> Plastic

3/4" Meter - Electronic Plastic

## Options

Mechanical Immediate Regeneration

Auxiliary Microswitch not wired

Auxiliary Microswitch wired included with ET

PVC Injector (for Potassium Permanganate) only with system 1600

NBP Piston (No By-Pass)

DLFC > 7 GPM (8, 9, 10, 12, 15 GPM) 1" Brass & reducer bushing

Filter *(without brine valve, injector / with plug)*

*(sans vanne à saumure, ni injecteur / avec bouchon) - (Ohne Solesystem, ohne Injektor / mit Stopfen) - (senza valvola salamoia, eiettore / con tappo) - (Sin válvula de salmuera, sin eyector / con un tapón)*

Filter

No Brine Valve

## Complete Valves Prices - Examples

2510 / Manual / Filter

2510 / 1650 3/4" Meter 8 m<sup>3</sup>

2510 / 1650 ET 3/4" Meter

# 2750 Valve

Packing Quantity 1

## Base Valve

2750 / 1600 Timeclock Mechanical

## Timer Choices

MANUAL / FILTER

MANUAL / FLOAT

SXT Timer

ET Timer

NXT Timer



## System

Duplex # 7 - Mechanical

## Meter Choices

3/4" Meter - 8 m <sup>3</sup>	Brass
3/4" Meter - 40 m <sup>3</sup>	Brass
3/4" Meter - Electronic	Brass with plastic cover
1" Meter - 20 m <sup>3</sup> brass	Brass
1" Meter - 100 m <sup>3</sup> brass	Brass
1" Meter - Electronic	Brass with plastic cover
1" Inline Meter - Electronic	Plastic

## Options

Brine valve 1710

Mechanical Immediate Regeneration

Up Flow regeneration

Auxiliary Microswitch not wired

Auxiliary Microswitch wired included with ET

PVC Injector (for Potassium Permanganate) only with system 1600

NBP Piston (No By-Pass)

DLFC > 7 GPM (8, 9, 10, 12, 15, 20, 25 GPM)

Filter (without brine valve, injector / with plug)

(sans vanne à saumure, ni injecteur / avec bouchon) - (Ohne Saalesystem, ohne Injektor / mit Stopfen) - (senza valvola salamoia, eiettore / con tapo) - (Sin válvula de salmuera, sin eyector / con un tapón)

Filter

No Brine Valve

Hot Water Timeclock up to 82° C

Hot Water 3/4" & 1" Meter up to 65° C - (except electronic version)

Hot water valves with 1700 BV and their options include all internal hot water resistant parts.

Les vannes Eau Chaude avec BV 1700 et leurs options comprennent toutes les pièces internes adaptées à cet usage. - Die Heißwasser Ventile mit 1700 Soleventile und deren Optionen enthalten alle internen Heißwasser beständigen Teile. - Le valvole per acqua calda con valvola salamoia 1700 e le loro opzioni comprendono tutti i particolari interni adattati per questo impiego. - Válvulas con válvula de salmuera 1700 y sus partes internas resistentes al agua caliente.

## Complete Valves Prices - Examples

2750 / Manual / Filter

2750 / 1600 3/4" Meter 8 m<sup>3</sup>

2750 / 1710 ET 1" Meter Brass

# 2850 Valve

Packing Quantity 1

## Base Valve

2850 / 1600 Timeclock Mechanical

## Timer Choices

MANUAL / FILTER

MANUAL / FLOAT

SXT Timer

ET Timer

NXT Timer



## System

Duplex # 7 - Mechanical

## Meter Choices

1" Meter - 20 m <sup>3</sup>	Brass
1" Meter - 100 m <sup>3</sup>	Brass
1" Meter - Electronic	Brass with plastic cover
1 ½" Meter - 40 m <sup>3</sup>	Brass
1 ½" Meter - 200 m <sup>3</sup>	Brass
1 ½" Meter - Electronic	Brass with plastic cover
1 ½" Inline Meter - Electronic	Plastic

## Options

Brine valve 1710

Mechanical Immediate Regeneration

Auxiliary Microswitch not wired

Auxiliary Microswitch wired included with ET

PVC Injector (for Potassium Permanganate) only with system 1600

NBP Piston (No By-Pass)

DLFC > 7 GPM (8, 9, 10, 12, 15, 20, 25 GPM) 1" Brass

DLFC - 30 GPM 1" Brass

DLFC - 35, 40, 45 GPM - 2850 Filter only 2" Brass

**Filter** *(without brine valve, injector / with plug)*  
*(sans vanne à saumure, ni injecteur / avec bouchon) - (Ohne Solesystem, ohne Injektor / mit Stopfen) - (senza valvola salamoia, eiettore / con tappo) - (Sin válvula de salmuera, sin inyector / con un tapón)*

Filter

No Brine Valve

Hot Water Timeclock up to 82° C

Hot Water 1" & 1 ½" Meter up to 65° C - (except electronic version)

*Hot water valves with 1700 BV and their options include all internal hot water resistant parts.*

*Les vannes Eau Chaude avec BV 1700 et leurs options comprennent toutes les pièces internes adaptées à cet usage. - Die Heißwasser Ventile mit 1700 Soleventile und deren Optionen enthalten alle internen Heißwasser beständigen Teile. - Le valvole per acqua calda con valvola salamoia 1700 e le loro opzioni comprendono tutti i particolari interni adattati per questo impiego. - Válvulas con válvula de salmuera 1700 y sus partes internas resistentes al agua caliente.*

## Complete Valves Prices - Examples

2850 Manual / Filter

2850 / 1600 1" Meter 100 m<sup>3</sup>

2850 / 1600 SXT 1 ½" Meter

# 2910 Valve

Packing Quantity 1

## Base Valve

2910 / 1600 Timeclock Mechanical

## Timer Choices

SXT Timer

ET Timer

NXT Timer

## System

Duplex # 7 - Mechanical

## Meter Choices

1 ½" Meter - 40 m <sup>3</sup>	Brass
1 ½" Meter - 200 m <sup>3</sup>	Brass
1 ½" Meter - Electronic	Brass with plastic cover
2" Meter - 75 m <sup>3</sup>	Brass
2" Meter - 375 m <sup>3</sup>	Brass
2" Meter - Electronic	Brass with plastic cover
2" Meter - 75 m <sup>3</sup>	Plastic
2" Meter - 375 m <sup>3</sup>	Plastic
2" Meter - Electronic	Plastic



## Options

Brine valve 1710

Mechanical Immediate Regeneration

Up Flow regeneration

Auxiliary Microswitch not wired

Auxiliary Microswitch wired

PVC Injector (for Potassium Permanganate) only with system 1600

NBP Piston (No By-Pass)

DLFC > 7 GPM (8, 9, 10, 12, 15, 20, 25 GPM) 1" Brass

DLFC - 30 GPM 1" Brass

Filter *(without brine valve, injector / with plug)*

*(sans vanne à saumure, ni injecteur / avec bouchon) - (Ohne Solesystem, ohne Injektor / mit Stopfen) - (senza valvola salamoia, eiettore / con tapo) - (Sin válvula de salmuera, sin eyector / con un tapón)*

Filter

No Brine Valve

Hot Water Timeclock up to 82° C

Hot Water 1 ½" & 2" Meter up to 65° C - (except electronic version)

*Hot water valves with 1700 BV and their options include all internal hot water resistant parts.*

*Les vannes Eau Chaude avec BV 1700 et leurs options comprennent toutes les pièces internes adaptées à cet usage. - Die Heißwasser Ventile mit 1700 Soleventile und deren Optionen enthalten alle internen Heißwasser beständigen Teile. - Le valvole per acqua calda con valvola salamoia 1700 e le loro opzioni comprendono tutti i particolari interni adattati per questo impiego. - Válvulas con válvula de salmuera 1700 y sus partes internas resistentes al agua caliente.*

## Complete Valves Prices - Examples

2910 / 1600 1"½ Meter 40 m<sup>3</sup>

2910 / 1710 2" Brass Meter 75 m<sup>3</sup>

2910 / 1600 SXT



# 3150 Valve

## Packing Quantity 1

### Base Valve

including microswitch not wired

3150 / 1800 Timeclock Mechanical

Top Mount

### Timer Choices

ET Timer

NXT Timer

### System

Duplex # 7 - Mechanical

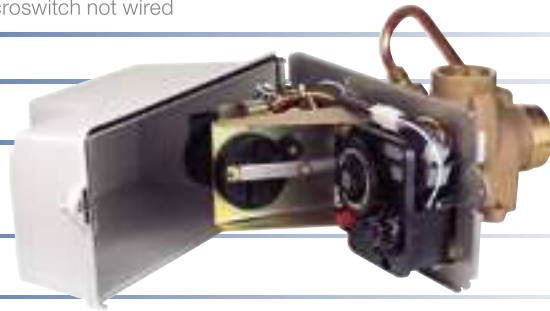

### Meter Choices

1 ½" Meter - 40 m³	Brass
1 ½" Meter - 200 m³	Brass
1 ½" Meter - Electronic	Brass with plastic cover
2" Meter - 75 m³	Brass
2" Meter - 375 m³	Brass
2" Meter - Electronic	Brass with plastic cover
2" Meter - 75 m³	Plastic
2" Meter - 375 m³	Plastic
2" Meter - Electronic	Plastic

### Options

Side Mount

Mechanical Immediate Regeneration

Up Flow regeneration

Auxiliary Microswitch wired included with ET

NBP Piston (No By-Pass)

DLFC - 25 to 100 GPM 2" Brass

Filter *(without brine valve, injector / with plug)*

*(sans vanne à saumure, ni injecteur / avec bouchon) - (Ohne Solesystem, ohne Injektor / mit Stopfen) - (senza valvola salamoia, eiettore / con tapo) - (Sin válvula de salmuera, sin eyector / con un tapón)*

Filter

No Brine Valve

Hot Water Timeclock up to 82° C

Hot Water 1 ½" & 2" Meter up to 65° C - (except electronic version)

*Hot water valves with 1700 BV and their options include all internal hot water resistant parts.*

*Les vannes Eau Chaude avec BV 1700 et leurs options comprennent toutes les pièces internes adaptées à cet usage. - Die Heißwasser Ventile mit 1700 Soleventile und deren Optionen enthalten alle internen Heißwasser beständigen Teile. - Le valvole per acqua calda con valvola salamoia 1700 e le loro opzioni comprendono tutti i particolari interni adattati per questo impiego. - Válvulas con válvula de salmuera 1700 y sus partes internas resistentes al agua caliente.*

### Complete Valves Prices - Examples

3150 / 1800 / Top Mount

3150 / 1800 / 2" Brass Meter 75 m³ / Side Mount

# 3900 Valve

Packing Quantity 1

## Base Valve

3900 / 1800 Timeclock Mechanical

Top Mount (threaded or flanged)

## Timer Choices

ET Timer

NXT Timer

## System

Duplex # 7 - Mechanical

## Meter Choices

3" Meter - 240 m<sup>3</sup>

Brass

3" Meter - 1 200 m<sup>3</sup>

Brass

3" Meter - Electronic

Brass with plastic cover



## Options

Side Mount

Mechanical Immediate Regeneration

Up Flow regeneration

Auxiliary Microswitch not wired

Auxiliary Microswitch wired

NBP Piston (No By-Pass)

DLFC - 25 to 100 GPM

2" Brass

Filter *(without brine valve, injector / with plug)*

*(sans vanne à saumure, ni injecteur / avec bouchon) - (Ohne Solesystem, ohne Injektor / mit Stopfen) - (senza valvola salamoia, eiettore / con tapo) - (Sin válvula de salmuera, sin eyector / con un tapón)*

Filter

No Brine Valve

## Complete Valves Prices - Examples

3900 / 1800 / Side Mount

3900 / 1800 / 3" Meter 240 m<sup>3</sup> Side Mount

3900 / 1800 NXT Top Mount

### NBP Piston



No By-Pass Piston: Automatic shut-off of the outlet during regeneration - no hard water by pass. Caution: This piston is not suitable for Duplex # 7 with single-piston valves. This piston is fitted as a standard item on double-piston valves (2910 and 3900) for multiplex systems.

Piston NBP : Fermeture automatique de la sortie pendant la régénération. Attention : Ce piston ne fonctionne pas pour les systèmes Duplex # 7 avec des vannes mono-pistons. Ce piston est monté en standard sur les vannes bi-pistons (2910 et 3900) pour les systèmes multiplex.

NBP Kolben: Automatische Wassersperre am Ausgang während der Regeneration. Merke: dieser Kolben ist für Duplex # 7 bei Einzelkolbenventilen nicht geeignet. NBP Kolben wird immer auf multiplex Systeme mit Doppelkolbenventile (2910 und 3900) eingebaut.

Pistone NBP: Chiusura automatica dell'uscita durante la rigenerazione. Attenzione: questo pistone non funziona per i sistemi duplex # 7 con valvole singolo-pistone. Questo pistone è montato in standard sulle valvole doppio-pistone (2910 e 3900) per sistemi multiplex.

Pistón NBP: Cierra automáticamente la salida durante la regeneración - No hay by-pass de agua dura. Atención: este pistón no es recomendable para equipos duplex # 7 con válvulas de un solo pistón. Este pistón se suministra como standard en las válvulas de doble pistón (2900 y 3900) en los sistemas multiplex.

### Duplex Systems # 7



Special wirings for Duplex are included in the valves prices. Duplex System # 7 alternating: 2 valves A & B, one in service, the second one in regeneration or stand-by. Duplex System # 7 = 2 valves for duplex systems (A & B) + 1 remote meter. For example if you want to order a 2910 Duplex # 7: order 2 valves 2910 (A & B) + 1 remote meter.

Câblages Duplex inclus dans le prix des vannes. Système Duplex # 7 alterné : 2 vannes - une en service, la seconde en régénération ou attente. Système Duplex # 7 : 2 vannes pour système duplex (A & B) + 1 compteur à distance (remote meter). Exemple : pour commander un Duplex 2910 # 7 : commander 2 vannes 2910 (A & B) + 1 compteur à distance (remote meter).

Verkabelung für Duplexanlage ist im Ventilpreis inbegriffen. Duplex System # 7 Alternating (Pendel): 2 Ventile A & B - ein in Betrieb, das zweite in Regeneration oder in Wartestellung. Duplex System # 7: 2 Ventile für Duplex Systeme (A & B) + 1 remote meter z.B. um ein 2910 Duplex # 7 zu bestellen: 2 Ventile 2910 2" Meter (A & B) + 1 remote meter.

Cablaggio duplex incluso nel prezzo delle valvole. Sistema duplex # 7 alternato: 2 valvole - una in servizio, la seconda in rigenerazione o in attesa. Sistema duplex # 7: 2 valvole per sistema duplex (A & B) + 1 remote meter Esempio: per ordinare uno duplex 2910 # 7: ordinare 2 valvole 2910 (A & B) + 1 remote meter.

El cableado especial para Duplex está incluido en el precio de la válvula. Sistema Duplex # 7 alternativo: 2 válvulas A & B, una en servicio, otra en regeneración o stand by Sistema Duplex # 7: 2 válvulas para sistema duplex (A & B) + 1 contador remoto Ej.: si se quiere pedir una 2910 duplex # 7: deben pedirse 2 válvulas 2910 (A & B) + 1 contador remoto.

#### **For multiplex systems, or any other special systems, please contact Pentair Water.**

Veuillez contacter Pentair Water pour toute autre demande, systèmes Multiplex ou autres. - Multiplex Systeme, oder andere spezifische Systeme, auf Anfrage bei Pentair Water erhältlich. - Per altre versioni, vi preghiamo di chiedere Pentair Water. - Para sistemas Multiplex, o especiales, contactar Pentair Water.

## REMOTE METERS

Reference	Application	Description	Packing Qty
<b>Simplex / Timer 3210 (Delayed) - 24 V / 50 Hz</b>			
27040-01	2750	20 m <sup>3</sup>	1
27042-01	2750	100 m <sup>3</sup>	1
27051-01	2850	40 m <sup>3</sup>	1
27053-01	2850	200 m <sup>3</sup>	1
27044-01	2910 & 3150	75 m <sup>3</sup>	1
27045-01	2910 & 3150	375 m <sup>3</sup>	1
27047-01	3900	240 m <sup>3</sup>	1
27049-01	3900	1200 m <sup>3</sup>	1
<b>Simplex / Timer 3220 (Immediate) - 24 V / 50 Hz</b>			
27055-01	2750	20 m <sup>3</sup>	1
27056-01	2750	100 m <sup>3</sup>	1
27057-01	2850	40 m <sup>3</sup>	1
27058-01	2850	200 m <sup>3</sup>	1
27059-01	2910 & 3150	75 m <sup>3</sup>	1
27060-01	2910 & 3150	375 m <sup>3</sup>	1
27061-01	3900	240 m <sup>3</sup>	1
27062-01	3900	1200 m <sup>3</sup>	1
<b>Duplex / Timer 3240 - 24 V / 50 Hz</b>			
28308-01	2910	40 m <sup>3</sup> # 7	1
28309-01	2910	200 m <sup>3</sup> # 7	1
27043-01	2910	75 m <sup>3</sup> # 7	1
26159-01	2910	375 m <sup>3</sup> # 7	1
27046-01	3900	240 m <sup>3</sup> # 7	1
27048-01	3900	1200 m <sup>3</sup> # 7	1
<b>Duplex / Timer 3245 - 24 V / 50 Hz</b>			
27039-01	2750	20 m <sup>3</sup> # 7	1
27041-01	2750 & 2850	100 m <sup>3</sup> # 7	1
27050-01	2850 & 3150	40 m <sup>3</sup> # 7	1
27052-01	2850 & 3150	200 m <sup>3</sup> # 7	1
27127-01	2850 & 3150	75 m <sup>3</sup> # 7	1
27128-01	2850 & 3150	375 m <sup>3</sup> # 7	1

Nota: mechanical remote meters can also be delivered in 110 V / 60 Hz (xxxxx-02) or in 230 V / 50 Hz (xxxxx-03)

Les compteurs remote mécaniques peuvent aussi être livrés en 110 V / 60 Hz (xxxxx-02) ou en 230 V / 50 Hz (xxxxx-03) - Die mechanischen Fernwasserzähler können auch in 110 V / 60 Hz (xxxxx-02) oder in 230 V / 50 Hz (xxxxx-03) ausgeliefert werden - Il remote meters meccanici possono anche essere consegnati in 110 V / 60 Hz (xxxxx-02) o in 230 V / 50 Hz (xxxxx-03) - El remote meters mecánicos pueden también suministrarse en 110 V / 60 Hz (xxxxx-02) o en 230 V / 50 Hz (xxxxx-03)

## REMOTE METERS

Reference	Application	Description	Packing Qty
<b>Duplex / Timer 3200 ET - 24 V / 50 Hz</b>			
<b>27716</b>	2750 & 2850	Electronic 1" # 7	1
<b>27717</b>	2850 & 3150	Electronic 1"½ # 7	1
<b>28289</b>	2910	Electronic 1"½ # 7	1
<b>27718</b>	2910	Electronic 2" # 7	1
<b>28273</b>	3150 & 2850	Electronic 2" # 7	1
<b>27719</b>	3900	Electronic 3" # 7	1



## NXT METERS & METER CABLES

Reference	Description	Packing Qty
-----------	-------------	-------------

All NXT valves are timeclock (except 2750 ¾"). Should you want an econominder version, you need to order a meter kit with the valve. Toutes les vannes NXT sont livrées en version chronométrique (à l'exception des 2750 ¾"). Pour une version volumétrique, vous devez commander un kit compteur (kit meter) en sus. - Alle NXT Ventile sind zeitgesteuert (außer Ventil 2750 ¾"). Bräuchten Sie eine mengengesteuerte Version, sollten Sie ein Wasserzähler Kit (meter kit) dazu bestellen. - Tutte le valvole NXT sono a tempo (salvo 2750 ¾"). Per avere una versione a volume, è necessario ordinare uno kit contatore (kit meter) in più. - Todas las válvulas NXT son cronométricas (excepto la 2750 ¾"). Si se requiere la versión volumétrica, debe solicitarse un kit contador.

# 5 - 1 meter kit/valve      # 6 - 1 meter kit/system      # 7 - 1 meter kit/system (2 valves only)      # 9 - 1 meter kit/valve

# 7 only for Duplex system ; in case of multiplex this is # 9

#7 uniquement pour systèmes Duplex ; #9 en cas de Multiplex - #7 nur für Duplexsysteme ; im Falle Multiplexsysteme, handelt es sich um #9 - #7 Solo per sistemi Duplex ; #9 in caso di Multiplex - #7 sólo para sistemas Duplex ; para los Multiplex es #9

### Kit Meter NXT

<b>28283</b>	Kit 1" Meter NXT	Brass	1
<b>28284</b>	Kit 1" ½ Meter NXT	Brass	1
<b>28285</b>	Kit 2" Meter NXT	Brass	1
<b>28295</b>	Kit 2" Meter NXT	Plastic	1
<b>28286</b>	Kit 3" Meter NXT	Brass	1

### Meter cables NXT

<b>28114-06</b>	Meter cable 700 mm		
<b>28114-08</b>	Meter cable 2500 mm delivered with each meter kits		1
<b>28114-09</b>	Meter cable 7700 mm		1

Nota: Kit communication cable (RJ45 - standard net work cable) can be ordered separately 41692 ethernet.

# YOKES

ADAPTATEURS - ANSCHLUSSADAPTER - ATTACCHI - ADAPTADORES

Reference	Description	Application	Packing Qty
<b>13398-10</b>	1" BSP female brass	Res - 2510 - 9000 - 9100	24
<b>24735</b>	1" BSP female brass mixing	9000 - 9100	24
<b>18706-10</b>	1" BSP male plastic	Res - 2510 - 9000 - 9100	24
<b>28354</b>	1" Connector Male BSP, Plastic QC (two Connectors needed per valve)	7700 - InLine Meter	24
<b>28355</b>	1 ¼" Connector Male BSP, Plastic QC (two Connectors needed per valve)	7700 - InLine Meter	24
<b>BU28569</b>	1 ½" Connector Male BSP, Plastic QC (two Connectors needed per valve)	InLine Meter	24
<b>24689</b>	¾" BSP male brass	Res - 2510 - 9000 - 9100	24
<b>18706-12</b>	¾" BSP male plastic	Res - 2510 - 9000 - 9100	24



18706-10



13398-10



24735



28354

# BY-PASS

Reference	Description	Application	Packing Qty
<b>BU28502</b>	1" BSP female Stainless Steel	Res - 2510 - 9000 - 9100	12
<b>24734-10</b>	1" BSP female brass with mixing	9000 ¾" - 9100 ¾"	12
<b>BU26054</b>	Plastic (no yoke)	Res - 2510 - 9000 - 9100	12
<b>28356</b>	By Pass 7700 Valve with Clips	7700	6



BU28502



28356



BU26054



24734-10

Res = residential valves / HW = hot water / UF = up flow.

All these articles can also be bought separately with an addition of 30 %.

Res. = vannes domestiques / HW = eau chaude / UF = contre courant.

Toutes ces pièces peuvent être vendues à l'unité avec un surcoût de 30 %.

Res. = Haushaltsventile / HW = heisswasser / UF = Gegenstrom.

Alle diese Teile können einzeln verkauft werden, mit einem Mehrpreis von 30 %.

Res. = valvole residenziali / HW = acqua calda / UF = up flow.

Tutti gli articoli possono essere acquistati separatamente, aggiungendo il 30% al prezzo indicato.

Res. = válvulas domesticas / HW = agua caliente / UF = up flow.

Todos los artículos se pueden comprar por separado añadiendo el 30% al precio indicado.



# SAFETY BRINE VALVES

VANNES DOUBLE SÉCURITÉ - SOLESICHERHEITSSCHWIMMVENTILE - VALVOLE SALAMOIA DI SICUREZZA - VÁLVULAS DE SALMUERA

Reference	Description	Application	Packing Qty
<b>27833</b>	SBV 2300 - without air-check	1600 & 1650	24
<b>27834</b>	SBV 2300 Hot Water - without air-check	1600 & 1650 HW	24
<b>60067-03</b>	SBV 2310 - without air-check	1600 & 1650	24
<b>25453</b>	SBV 2350 - without air check	1700 - 1710 & 1800	5
<b>25364</b>	Mounting part 1" NPT male x 3/8" female	1700 & 1710 with SBV 2350	5
<b>28182</b>	Union PVC fem. 1" to be glued - male 1" BSP	1800 with SBV 2350	5
<b>25687</b>	BV 44 - 914 mm	1600 & 1650	10
<b>18961</b>	BV 44 - 1250 mm	1600 & 1650	10

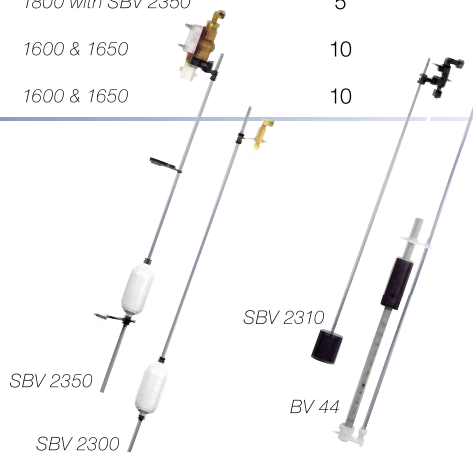

# AIR CHECKS

SOUPAPES ANTI-AIR - LUFTSPERRE - AIR CHECKS - AIR CHECKS

Reference	Description	Application	Packing Qty
<b>18168</b>	A.C. 500A 915 mm (36")	1600 & 1650	48
<b>26773</b>	A.C. 500A 1250 mm	1600 & 1650	48
<b>23473</b>	A.C. 500 Hot Water	1600 HW	48
<b>18979</b>	A.C. 900 1 m 88	1700 - 1710 & 1800	5
<b>BU28510</b>	A.C. 900 1 m 10	1700 - 1710 & 1800	5
<b>18980</b>	A.C. 900 Hot Water	1700 & 1800 HW	5



Res = residential valves/HW = hot water/UF = up flow.  
 All these articles can also be bought separately with an addition of 30 %.  
 Res. = vannes domestiques/HW = eau chaude/UF = contre courant.  
 Toutes ces pièces peuvent être vendues à l'unité avec un surcoût de 30 %.  
 Res. = Haushaltsventile/HW = heisswasser/UF = Gegenstrom.  
 Alle diese Teile können einzeln verkauft werden, mit einem Mehrpreis von 30 %.

Res. = valvole residenziali/HW = acqua calda/UF = up flow.  
 Tutti gli articoli possono essere acquistati separatamente, aggiungendo il 30% al prezzo indicato.  
 Res. = válvulas domesticas/HW = agua caliente/UF= up flow.  
 Todos los artículos se pueden comprar por separado añadiendo el 30% al precio indicado.

# DISTRIBUTORS

DISTRIBUTEURS - VERTEILERROHRE - DISTRIBUTORI - DISTRIBUIDORES

Reference	Description	Application	Packing Qty
<b>Distributor Assy</b>			
<b>27827</b>	1" high flow 1 m 10	Res.-2510-2750-9000-9100	24
<b>25645</b>	1" high flow 1 m 95	Res.-2510-2750-9000-9100	24
<b>BU28508</b>	1" high flow Hot Water 1 m 10	2750 - 4600 - 9000	24
<b>21675</b>	1" high flow Hot Water 1 m 95	2750 - 4600 - 9000	24
<b>27828</b>	1" UF & high capacity 1 m 10	Res.-UF	24
<b>BU28509</b>	1" high capacity Hot Water 1 m 10	4600 - 9000	24
<b>25639</b>	1" high capacity Hot Water 1 m 88	4600 - 9000	24
<b>18404</b>	2" 1 m 82	2850 - 2910 - 9500	5
<b>BU26052</b>	2" Hot Water 1 m 82	2850 - 2910 - 9500	5
<b>Bottom Distributors</b>			
<b>25360</b>	1" high flow	Res.-2510-2750-9000-9100	100
<b>27106</b>	1" high flow Hot Water	2750 - 4600 - 9000	50
<b>25797</b>	1" UF & high capacity	Res.-UF	50
<b>27109</b>	1" high capacity Hot Water	4600 - 9000	50
<b>18396</b>	2"	2850 - 2910 - 9500	5
<b>26050</b>	2" Hot Water	2850 - 2910 - 9500	5
<b>1002-D32</b>	32 mm Bottom Distributor High Flow	Res.-7700	12
<b>Distributor Tubes</b>			
<b>27826</b>	1" 1 m 06	Res.-2510-2750-9000-9100	25
<b>BU28650</b>	1" ACS 1 m 06	Res.-2510-2750-9000-9100	24
<b>21874</b>	1" 1 m 85	Res.-2510-2750-9000-9100	25
<b>BU28648</b>	1" ACS 1 m 85	Res.-2510-2750-9000-9100	24
<b>BU28507</b>	1" Hot Water 1 m 06	4600 - 2750 - 9000	25
<b>12165-01</b>	1" Hot Water 1 m 78	4600 - 2750 - 9000	25
<b>21148-01</b>	2" 1 m 66	2850 - 2910 - 9500	25
<b>BU28649</b>	2" ACS 1 m 66	2850 - 2910 - 9500	5
<b>21148HW</b>	2" Hot Water 1 m 66	2850 - 2910 - 9500	25

## IN-LINE METERS for SXT, ET & NXT

Kit Meter In-Line Assy, with threaded connections and meter cable

Kit compteur In-Line, avec raccords filetés et câble de compteur - Kit In-Line Wasserzähler, mit Gewindeanschlüssen und Wasserzählerkabel -

Contatore volumetrico completo con attacchi filettati maschio e cavo contatore. - Kit contador In-Line, con racords roscados y cable contador.

Reference	Connection Size	Application	Packing Qty
<b>28461-02</b>	1" BSP plastic	2750	1
<b>28461-04</b>	1" ¼ BSP plastic	2750, 2850, 2910	1
<b>28461-14</b>	1" ½ BSP plastic	2850, 9500	1



Res = residential valves/HW = hot water/UF = up flow.

All these articles can also be bought separately with an addition of 30 %.

Res. = vannes domestiques/HW = eau chaude/UF = contre courant.

Toutes ces pièces peuvent être vendues à l'unité avec un surcoût de 30 %.

Res. = Haushaltsventile/HW = heisswasser/UF = Gegenstrom.

Alle diese Teile können einzeln verkauft werden, mit einem Mehrpreis von 30 %.

Res. = valvole residenziali/HW = acqua calda/UF = up flow.

Tutti gli articoli possono essere acquistati separatamente, aggiungendo il 30% al prezzo indicato.

Res. = válvulas domesticas/HW = agua caliente/UF= up flow.

Todos los artículos se pueden comprar por separado añadiendo el 30% al precio indicado.

## OTHERS

AUTRES - ANDERE - ALTRI - OTROS

Reference	Description	Application	Packing Qty
18122	Kit flexible 2nd tank adapter - 200 mm	9000	10
18123	Kit flexible 2nd tank adapter - 400 mm	for assembly	10
18124	Kit flexible 2nd tank adapter - 500 mm	with yoke 1" female	5
28137-16	Kit copper tubes 2nd tank adapter - 16"	9500	1
28137-20	Kit copper tubes 2nd tank adapter - 20"	9500	1
28137-24	Kit copper tubes 2nd tank adapter - 24"	9500	1
BU61564-10	Mixing Assy 1" BSP	Industrial	1
61415-20	Rotating Side Mount Adapter	2850 - 2910	1

## ACCESSORIES DELIVERED WITH BUT NOT FITTED TO VALVES

ACCESSOIRES LIVRÉS MAIS NON MONTÉS SUR LES VANNES - ZUBEHÖRE, MIT VENTIL GELIEFERT, JEDOCH NICHT AUFGEBAUT - ACCESSORI CONSEGNATI MA NON MONTATI SULLE VALVOLE - ACCESORIOS SUMINISTRADOS PERO NO MONTADOS EN LAS VÁLVULAS

### For brine systems 1600 & 1650 (KIT 51):

pour système de saumurage 1600 & 1650 - für Solesysteme 1600 & 1650 - per sistema salamoia 1600 & 1650 - para válvulas de aspiración salmuera tipo 1600 ó 1650  
1 tube guide 24575 - 1 filter 12767 - 1 elbow ¾" 12794-01 - 3 insert tubes ¾" 10332 - 1 sleeve ¾" 10330

### For brine systems 1700 & 1710 (KIT 57):

pour système de saumurage 1700 & 1710 - für Solesysteme 1700 & 1710 - per sistema salamoia 1700 & 1710 - para válvulas de aspiración salmuera tipo 1700 (Kit 57)  
1 male elbow ½" 15413 - 1 fitting ¾" 23804 - 2 insert tubes ½" 15415 - 2 sleeves ½" 16124 - 1 nut ½" BR16123

### For brine systems 1800 (KIT 78):

pour système de saumurage 1800 - für Solesysteme 1800 - per sistema salamoia 1800 - para válvulas de aspiración salmuera tipo 1800 (Kit 78)  
2 PVC Union female 1" BSP 28181 - 1 male pipe fitting 1" 16453

**Residential valves** are delivered with couplings, clips and screws necessary to fit the yoke.

**Les vannes domestiques** sont livrées avec les couplings, clips et vis pour le montage du yoke. - **Haushaltsventile** werden mit Coupling, Clips und Schrauben für die Montage vom Yoke geliefert. - **Le valvole domestiche** sono consegnate con coupling, clip e viti per il montaggio del joke - **Válvulas domésticas** se entregan con los acopladores, clips y tornillos necesarios para montar el yoke.

### Other Kits (coupling/small parts/top distributors) delivered with valves:

2510 Time Clock	KIT 256	2510 Meter	KIT 257
7700	28357	9000	BU28319
9000/6	BU28320	9100	BU28321

# VALVE PRICES INCLUDE

## “CE” Compliance

All our valves comply with the requirements of the European Directives 89/336/CEE “Electromagnetic Compatibility” and/or 73/23/CEE “Low Voltage”. Therefore we deliver our valves :

- **4600, 5600** in 230 V / 50/60 Hz
- **4600SXT, 5000SXT, 5600SE, 5600SXT, 6600, 6700, 7700, 9000, 9100, 9500** in 24 V with transformer 230-24 V / 50/60 Hz, 10 VA
- **2510, 2750, 2870, 2910, 3150** in 24 V with transformer 230-24 V / 50/60 Hz, 60 VA
- **3900** in 24 V with transformer 230-24 V / 50/60 Hz, 105 VA

## “RoHS” Compliance

Our products are RoHS compliant

## Industrial Valves (all with Grey cover(s) Pro II)

### Valves 2510 - 2750:

- 2510: Top 1" BU28511 (Filter: BU28511-01)
- 2750: Top 1" bayonet 18280 (Filter 18280-01)
- Drain hose barb ½" 13308 (2750) 21511 (2510)

### Valves 2850 – 2910:

- Top(s) 2" KIT 8

### Valves 3900:

- Flow disperser 3" 16258 (for Top Mount versions)

## Residential Valves

### Valves 4600 - 5600:

- Top 1" bayonet 18280 (5600 Filter 18280-01)
- Drain hose barb ½" 13308
- Proportional Mixing
- Standard or LWU (Low Water Usage) piston
- Service & Regeneration lights

### Valves 5665 C.R.:

- 24 V + Transfo 230/24-8 V 18355
- Upflow brining + pressure regulator
- 4 days regeneration override (5665 R)
- Top 1" bayonet 18280
- Drain hose barb ½" 13308
- Proportional Mixing
- Antiback-flow system
- Desinfection lights
- Chlorinator
- Vacation switch

### Valves 6600 - 6700 dito 5600 with:

#### Valves 6665 - 6765 dito 5665 with:

- Electronic board 6600 and 6700 respectively
- Desinfection indicator in the LCD display (6665 - 6765)
- Programmable vacation position (no switch) on 6665 / 6765

### Valves 5600SE dito 5600 with:

- Electronic board SE - LCD display

### Valves 4600 SXT - 5600 SXT dito 5600 with:

- Electronic board SXT - LED display

### Valves 5000SXT:

- Top 1" bayonet 18280 (Filter 18280-01)
- ½" Drain elbow 21511
- Proportional Mixing
- Electronic board SXT - LED display
- Black smoked cover

### Valves 7700 Standard:

- Brine Fitting ¾" (0,25 to 1,0 BLFC Button)
- ¾" 90° Drain Elbow (0,8 to 7,0 DLFC Button) or 1" straight Drain Elbow (8 to 25 DLFC Button)
- Proportional mixing
- Pilot tube 1" / Top Distributor 1" bayonet BU28511
- Two I/O Clips 40576
- No Connector (to be ordered separately as accessories)
- Grey Cover

### Valves 7700 High Flow dito 7700 with:

- Pilot tube 32mm with 1" reduction kit
- Top Distributor 32mm bayonet 1001-32IB
- No proportional mixing

### Valves 7700 Filter dito 7700 with :

- Pilot tube 1" / Top Distributor 1" bayonet BU28511-01
- Auxilliary Microswitch (no wiring)

## Twin valves

### Valves 9000 / 9100:

- 9000: Tops 1" bayonet 18280
- 9100: Tops 1" bayonet BU28511
- Drain elbow ½" 21511
- 2<sup>nd</sup> Tank adapter with couplings 24238 (9000)
- 2<sup>nd</sup> Tank adapter 28242 (9100)
- Black cover

### Valves 9000/6 dito 9000 with:

- PVC connecting tubes 25146 & 25147
- Pressure regulator and anti back-flow

### Valves 9500:

- Tops 2" KIT 17
- 2<sup>nd</sup> Tank adapter 18050
- Black cover

### 9100 only :

- PVC connecting tubes 7", 9", 12" or 16" 28243-xx

# SONT INCLUS DANS LES PRIX DES VANNES

## Conformité "CE"

Toutes nos vannes sont conformes aux Directives Européennes 89/336/CEE "Compatibilité Electromagnétique" et/ou 73/23/CEE "Basse Tension". Pour ce faire nous livrons les vannes :

- **4600, 5600** en 230 V/50/60 Hz
- **4600SXT, 5000SXT, 5600SE, 5600SXT, 6600, 6700, 7700, 9000, 9100, 9500** en 24 V avec transformateur 230-24 V/50/60 Hz, 10 VA
- **2510, 2750, 2870, 2910, 3150** en 24 V avec transformateur 230-24 V/50/60 Hz, 60 VA
- **3900** en 24 V avec transformateur 230-24 V/50/60 Hz, 105 VA

## Conformité "RoHS"

Nos produits sont conformes aux Directives "RoHS"

## Vannes industrielles (avec couvercle(s) gris Pro II)

### Vannes 2510 - 2750 :

- 2510: Crépine supérieure 1" BU28511 (Filtre: BU28511-01)
- 2750: Crépine supérieure 1" 18280 (Filtre: 18280-01)
- Raccord à l'égoût ½" 13308 (2750) 21511 (2510)

### Vannes 2850 - 2910 :

- Crépine supérieure 2" KIT 8

### Vannes 3900 :

- Eclateur de flux 3" 16258 (pour versions à montage en tête)

## Vannes domestiques

### Vannes 4600 - 5600 :

- Crépine supérieure baïonnette 1" 18280 (5600 Filtre 18280-01)
- Raccord à l'égoût ½" 13308
- Mixing Proportionnel
- Piston standard ou économique LWU (Low Water Usage)
- Voyants: Service - Régénération

### Vannes 5665 C.R. :

- 24 V + Transfo 230/24-8 V 18355
- Saumurage à contre - courant + régulateur de pression
- Forçage 4 jours (5665 R)
- Crépine supérieure baïonnette 1" 18280
- Raccord à l'égoût ½" 13308
- Clapet anti-retour
- Voyants: Désinfection
- Chlorinateur
- Interrupteur vacances

### Vannes 6600 - 6700 dito 5600 avec :

### Vannes 6665 - 6765 dito 5665 avec :

- Carte électronique 6600 et 6700, respectivement
- Indicateur désinfection intégré dans l'afficheur LCD (6665 - 6765)
- Position vacances programmable (pas d'interrupteur) 6665/6765

### Valves 5600SE dito 5600 avec :

- Carte électronique SE - Afficheur LCD

### Valves 4600 SXT - 5600 SXT dito 5600 avec:

- Carte électronique SXT - Afficheur LED

### Vannes 5000SXT :

- Crépine supérieure baïonnette 1" 18280 (Filtre 18280-01)
- ½" Raccord coudé à l'égoût 21511
- Mixing proportionnel
- Carte électronique SXT - Afficheur LED
- Couvercle noir fumé

### Vannes 7700 Standard :

- Brine Fitting ¾" (BLFC 0,25 à 1,0)
- ¾" 90° Raccord coudé à l'égoût (DLFC 0,8 à 7,0) ou 1" Raccord droit à l'égoût (DLFC 8 à 25)
- Mixing proportionnel
- Tube pilote 1"/Crépine supérieure baïonnette 1" BU28511
- Deux clips entrée/sortie 40576
- Pas de raccords (à commander séparément en tant qu'accessoires)
- Couvercle gris

### Vannes 7700 High Flow dito 7700 avec :

- Tube pilote 32 mm avec kit de réduction 1"
- Crépine supérieure 32 mm baïonnette 1001-321B
- Pas de mixing proportionnel

### Vannes 7700 Filter dito 7700 avec :

- Tube pilote 1"/Crépine supérieure 1" baïonnette BU28511-01
- Microswitch auxiliaire (non câblé)

## Twin valves

### Vannes 9000 / 9100 :

- 9000: Crépines supérieures 1" baïonnette 18280
- 9100: Crépines supérieures 1" baïonnette BU28511
- Raccord coudé à l'égoût ½" 21511
- 2<sup>nd</sup> adaptateur bouteille avec couplings 24238 (9000)
- 2<sup>nd</sup> adaptateur bouteille 28242 (9100)
- Couvercle noir

### Vannes 9000/6 dito 9000 avec :

- Tubes de liaison PVC 25146 & 25147
- Régulateur de pression et clapet anti-retour

### Vannes 9500 :

- Crépines supérieures 2" Kit 17
- 2<sup>nd</sup> adaptateur bouteille 18050
- Couvercle noir

### 9100 seulement :

Tubes de liaison PVC 7", 9", 12" ou 16" 28243-xx

# SIND IM VENTILPREIS ENTHALTEN

## “CE” Markierung

Alle unsere Ventile entsprechen den europäischen Richtlinien 89/336/CEE “Elektromagnetische Verträglichkeit” und/oder 73/23/CEE “Niederspannung”. Deswegen liefern wir die Ventile

- **4600, 5600** in 230 V/50/60 Hz
- **4600SXT, 5000SXT, 5600SE, 5600SXT, 6600, 6700, 7700, 9000, 9100, 9500** in 24 V mit Transformator 230-24 V/50/60 Hz, 10 VA
- **2510, 2750, 2870, 2910, 3150** in 24 V mit Transformator 230-24 V/50/60 Hz, 60 VA
- **3900** in 24 V mit Transformator 230-24 V/50/60 Hz, 105 VA

## “RoHS” Richtlinien

Unsere Produkte entsprechen den “RoHS” Richtlinien

## Industrie Ventile (alle mit graue(r/n) Abdeckhaube(n) Pro II)

### Ventile 2510 – 2750:

- 2510: Obere Düse 1" BU28511 (Filter: BU28511-01)
- 2750: Obere Düse 1" 18280 (Filter: 18280-01)
- Schlauchtülle ½" 13308 (2750) 21511 (2510)

### Ventile 2850 – 2910:

- Obere Düse 2" Kit 8

### Ventile 3900:

- Verteiler 3" 16258  
(für Top Montage Versionen)

## Haushaltsventile

### Ventile 4600 – 5600:

- Obere Düse 1" Bajonettanschluß 18280 (5600 Filter 18280-01)
- Schlauchtülle ½" 13308
- Proportionale Verschneidung
- Standard oder Sparkolben LWU (Low Water Usage)
- Anzeigeleuchten: Betrieb – Regeneration

### Ventile 5665 C.R.:

- 24 V + Transfo 230/24-8 V 18355
- Gegenstromregeneration + Druckregler
- 4 Tage Zwangsregeneration (5665 R)
- Obere Düse 1" Bajonettanschluß 18280
- Schlauchtülle ½" 13308
- Proportionale Verschneidung
- Rückflußsperre
- Anzeigeleuchten: Desinfektionsleuchten
- Chlorerzeuger
- Ferienschalter

### Ventile 6600 – 6700 wie 5600 mit:

#### Ventile 6665 – 6765 wie 5665 mit:

- Elektronische Steuerung 6600 und 6700
- Integrierte Desinfektionsanzeige im LCD Display (6665 - 6765)
- Programmierbare Ferienposition (kein Schalter) bei 6665/6765

### Ventile 5600SE wie 5600 mit:

- Elektronische Steuerung SE - LCD display

### Ventile 4600 SXT – 5600 SXT wie 5600 mit:

- Elektronische Steuerung SXT - LED display

### Ventile 5000SXT:

- Obere Düse 1" Bajonettanschluß 18280 (Filter 18280-01)
- ½" Schlauchtülle gebogen 21511
- Proportionale Verschneidung
- Elektronische Steuerung SXT - LED display
- Schwarze Abdeckhaube

### Ventile 7700 Standard:

- Soleanschluß ¾" (0,25 bis zu 1,0 BLFC Blende)
- ¾" 90° Schlauchtülle (0,8 bis zu 7,0 DLFC Blende) oder 1" gerade Schlauchtülle (8 bis zu 25 DLFC Blende)
- Proportionale Verschneidung
- Pilot tube 1"/obere Düse 1" Bajonettanschluß 18280
- Zwei Clips Eingang/Ausgang BU28511
- Keine Anschlüsse (Connector - sollen separat als Zubehöre bestellt werden)
- Graue Abdeckhaube

### Ventile 7700 High Flow wie 7700 mit:

- Pilot tube 32 mm mit 1" Reduzierungskit
- Obere Düse 32 mm Bajonettanschluß 1001-32IB
- Keine proportionale Verschneidung

### Ventile 7700 Filter wie 7700 mit:

- Pilot tube 1"/obere Düse 1" Bajonettanschluß BU28511-01
- Zusätzliche Mikroschalter (keine Verkabelung)

## Twin Ventile

### Ventile 9000 / 9100:

- 9000: Obere Düse 1" Bajonettanschluß 18280
- 9100: Obere Düse 1" Bajonettanschluß BU28511
- ½" Schlauchtülle gebogen 21511
- 2<sup>ten</sup> Flaschenadapter mit couplings 24238 (9000)
- 2<sup>ten</sup> Flaschenadapter 28242 (9100)
- Schwarze Abdeckhaube

### Ventile 9000/6 wie 9000 mit:

- PVC Verbindungsrohre 25146 & 25147
- Druckregler und Rückflußsperre

### Ventile 9500:

- Obere Düse 2" Kit 17
- 2<sup>ten</sup> Flaschenadapter 18050
- Schwarze Abdeckhaube

### Nur bei 9100:

- PVC Verbindungsrohre 7", 9", 12" oder 16" 28243-xx



# SONO INCLUSI NEI PREZZI

## “CE” Conformità

Tutte le valvole sono conformi alle Direttive Europee (89/336/CEE) “Compatibilità Elettromagnetica” e/o 73/23/CEE “Low Voltage”.  
Dunque consegnamo nostre valvole:

- **4600, 5600** in 230 V/50/60 Hz
- **4600SXT, 5000SXT, 5600SE, 5600SXT, 6600, 6700, 7700, 9000, 9100, 9500** in 24 V con trasformatore 230-24 V/50/60 Hz, 10 VA
- **2510, 2750, 2870, 2910, 3150** in 24 V con trasformatore 230-24 V/50/60 Hz, 60 VA
- **3900** in 24 V con trasformatore 230-24 V/50/60 Hz, 105 VA

## “RoHS” Conformità

Tutti i nostri prodotti sono conformi alle Direttive “RoHS”

## Valvole Industriale (tutte con un coperchio grigio Pro II)

### Valvole 2510 - 2750:

- 2750: Diffusore superiore 1" 18280 (Filtro: BU28511-01)
- 2750: Diffusore superiore 1" 18280 (Filtro: 18280-01)
- Raccordo allo scarico 1/2" 13308 (2750) 21511 (2510)

### Valvole 2850 – 2910:

- Diffusore superiore 2" Kit 8

### Valvole 3900:

- Flow disperser 3" 16258 (per versioni montaggio in testa)

## Valvole domestiche

### Valvole 4600 - 5600:

- Diffusore superiore 1" baionetta 18280 (5600 Filtro 18280-01)
- Raccordo allo scarico 1/2" 13308
- Miscelatore proporzionale
- Pistone standard o pistone risparmio acqua (LWU)
- Lampadine: Servizio - Rigenerazione

### Valvole 5665 C.R.:

- 24 V + Trasfo 230/24-8 V 18355
- Salamoia contro-corrente + Regolatore di pressione
- Forzatura 4 giorni (5665 R)
- Diffusore superiore 1" baionetta 18280
- Raccordo allo scarico 1/2" 13308
- Miscelatore proporzionale
- Valvola non-ritorno
- Lampadine: Disinfezione
- Clorinatore
- Interruttore vacanze

### Valvole 6600 - 6700 simile 5600 con:

#### Valvole 6665 - 6765 simile 5665 con:

- Scheda elettronica 6600 e 6700 rispettivamente
- Indicatore disinfezione integrato nel display LCD (6665 - 6765)
- Posizione vacanze programmabile (no interruttore) per 6665/6765

### Valvole 5600SE simile 5600 con:

- Scheda elettronica SE - Display LCD

### Valvole 4600 SXT - 5600 SXT simile 5600 con:

- Scheda elettronica SXT - Display LED

### Valvole 5000SXT:

- Diffusore superiore 1" baionetta 18280 (Filtro 18280-01)
- Raccordo allo scarico 1/2" 21511
- Miscelatore proporzionale
- Scheda elettronica Sxt - Display LED
- Coperchio nero affumicato

### Valvole 7700 Standard:

- Raccordo salamoia 3/8" (BLFC da 0,25 a 1,0)
- Raccordo a gomito allo scarico 3/4" 90° (DLFC da 0,8 a 7,0) o raccordo diritto allo scarico 1" (DLFC da 8 a 25)
- Miscelatore proporzionale
- Tubo pilota 1" / Diffusore superiore 1" baionetta BU28511
- Due Clip entrata/uscita 40576
- No connettore (da ordine a parte come accessori)
- Coperchio grigio

### Valvole 7700 High Flow simile 7700 con:

- Tubo pilota 32 mm con kit riduzione 1"
- Diffusore superiore 32 mm baionetta baionetta 1001-32IB
- No miscelatore proporzionale

### Valvole 7700 Filter simile 7700 con:

- Tubo pilota 1" / Diffusore superiore 1" baionetta BU28511-01
- Microswitch ausiliario (non cablato)

## Valvole Twin

### Valvole 9000 / 9100:

- 9000: Diffusori superiori 1" baionetta 18280
- 9100: Diffusori superiori 1" baionetta BU28511
- Raccordo allo scarico 1/2" 21511
- 2° adattatore bombola con couplings 24238 (9000)
- 2° adattatore bombola 28242 (9100)
- Coperchio nero

### Valvole 9000/6 simile 9000 con:

- Raccordi PVC 25146 & 25147
- Regolatore di pressione all'aspirazione e valvola non-ritorno

### Valvole 9500:

- Diffusori superiori 2" Kit 17
- 2° adattatore bombola 18050
- Coperchio nero

### 9100 solamente:

- Raccordi PVC 7", 9", 12" o 16" 28243-xx

# EL PRECIO DE LAS VÁLVULAS INCLUYE

## Conformidad de las directivas "CE"

Todas nuestras válvulas cumplen las directivas europeas 89/336/CEE de "Compatibilidad Electromagnética y/o 73/23/CEE de "Baja Tensión". Por tanto, suministramos nuestras válvulas:

- **4600, 5600** a 230 V/50/60 Hz
- **4600SXT, 5000SXT, 5600SE, 5600SXT, 6600, 6700, 7700, 9000, 9100, 9500** a 24 V con transformador 230-24 V/50/60 Hz, 10 VA
- **2510, 2750, 2870, 2910, 3150** a 24 V con transformador 230-24 V/50/60 Hz, 60 VA
- **3900** a 24 V con transformador 230-24 V/50/60 Hz, 105 VA

## Conformidad RoHS

Todos nuestros productos cumplen con las Directivas RoHS

## Válvulas Industriales (Todas con tapa(s) gris Pro II)

### Válvulas 2510 - 2750:

- 2510: Crepina superior 1" 18280 (Filtro: BU28511-01)
- 2750: Crepina superior 1" 18280 (Filtro: 18280-01)
- Desagüe para manguera 1/2" 13308 (2750) 21511(2510)

### Válvulas 2850 - 2910:

- Diffusore superiore 2" Kit 8

### Válvulas 3900:

- Dispersador de flujo de 3" 16258 (para la versión de montaje superior)

## Válvulas domésticas

### Válvulas 4600 - 5600:

- Crepina superior 1" bayoneta 18280 (5600 Filtro 18280-01)
- Desagüe para manguera 1/2" 13308
- Mezclador proporcional
- Pistón standard o LWU (Bajo consumo)
- Luces de servicio & regeneración

### Válvulas 5665 C.R.:

- 24 V + Transformador 230/24-8 V 18355
- Aspiración contracorriente + regulador de presión
- Regeneración obligatoria cada 4 días (5665 R)
- Crepina superior 1" bayoneta 18280
- Desagüe para manguera 1/2" 13308
- Mezclador proporcional
- Sistema anti retorno
- Luz piloto indicando desinfección
- Clorador
- Interruptor de vacaciones

### Válvulas 6600 - 6700 igual que la 5600 plus:

### Válvulas 6665 - 6765 igual que la 5665 plus:

- Programador Electrónico 6600 - 6700
- Indicador de desinfección en el display LCD (6665 - 6765)
- Posición vacaciones programable (sin interruptor) 6665/6765

### Válvulas 5600SE igual que la 5600 plus:

- Scheda elettronica SE - Display LCD

### Válvulas 4600 SXT - 5600 SXT igual que la 5600 plus:

- Scheda elettronica SXT - Display LED

### Válvulas 5000SXT:

- Crepina superior 1" bayoneta 18280 (Filtro 18280-01)
- Codo de desagüe 1/2" 21511
- Mezclador proporcional
- Programador Electrónico SXT - display LED
- Tapa negra ahumada

### Válvulas 7700 Standard:

- Conexión aspiración de salmuera de 3/8" (BLFC 0,25 a 1,0)
- Codo de desagüe de 90° de 3/4" (DLFC 0,8 a 7,0) o conexión a desagüe recta de 1" (DLFC 8 a 25)
- Mezclador proporcional
- Tubo colector 1"/Crepina superior 1" bayoneta BU28511
- Dos clips entrada/salida 40576
- Sin conexiones de entrada/salida (deben pedirse separadamente como accesorio)
- Tapa gris

### Válvulas 7700 High Flow igual que la 7700 plus:

- Tubo colector 32 mm. con kit de reducción 1"
- Crepina superior 32 mm bayoneta 1001-32B
- Sin mezclador proporcional

### Válvulas 7700 Filter igual que la 7700 plus:

- Tubo colector 1"/Crepina superior bayoneta 1" BU28511-01
- Micro interruptor auxiliar (sin cables)

## Válvulas Twin

### Válvulas 9000 / 9100:

- 9000: Crepinas superiores 1" bayoneta 18280
- 9100: Crepinas superiores 1" bayoneta BU28511
- Codo de desagüe 1/2" 21511
- Adaptador 2ª botella con acoplamiento 24238(9000)
- Adaptador 2ª botella (9100)
- Tapa negra

### Válvulas 9000/6 igual que la 9000 plus:

- Tubos de conexión PVC 25146 & 25147
- Regulador de presión a clapeta anti-retorno

### Válvulas 9500:

- Crepinas superiores 2" KIT 17
- Adaptador de la 2ª botella 18050
- Tapa negra

### Únicamente para las válvulas 9100:

- Tubos de conexión PVC 7", 9", 12" o 16" 28243-xx

# DEDUCTIONS

When valves are ordered less the following items.

Déductions pour vannes sans les options suivantes. - Abzüge bei Ventilen ohne folgende Teile. - Diminuzione per valvole ordinate senza le seguenti opzioni. - Cuando se piden las válvulas sin los siguientes items.

Description	Application
<b>Brine valves</b>	
<b>1600 BV Plastic</b>	4600, 5000SXT, 5600, 5600SE, 5600SXT, 6600, 6700, 7700, 9000, 9100
<b>1600 BV Brass</b>	2750, 2850, 2910, 9500
<b>1650 BV Plastic</b>	2510
<b>1800 BV Brass</b>	3150, 3900
<b>DLFC up to 7 GPM</b>	
<b>2510, 5000SXT (plastic)</b>	
<b>2750, 2850, 2910, 9500 (brass)</b>	
<b>4600, 5600, 5600SE, 5600SXT, 6600, 6700 (washer + retainer)</b>	
<b>7700 (washer)</b>	
<b>Miscellaneous Deductions</b>	
<b>Mixing</b>	4600, 5000SXT, 5600, 5600SE, 5600SXT, 6600, 6700
<b>Electromechanical timer</b>	3200 series 9000, 9100, 9500
<b>Service/Regeneration Lights</b>	4600, 5600
<b>Transformers</b>	
<b>5000SXT, 5600SE, 5600SXT, 6600, 6700, 7700, 9000, 9100, 9500</b>	without transformer 10 VA
<b>2510, 2750, 2850, 2910, 3150</b>	without transformer 60 VA
<b>3900</b>	without transformer 105 VA
<b>Collectors and flow disperser</b>	
<b>1"</b>	<b>2510, 2750, 4600, 5000SXT, 5600, 5600SE, 5600SXT, 6600, 6700, 9000 (x2), 9100 (x2)</b>
<b>2"</b>	<b>2850, 2910, 9500 (x2)</b>
<b>3"</b>	<b>3900 (flow disperser)</b>

**Fleck Products  
General Warranty**



## FLECK PRODUCTS - GENERAL WARRANTY

The products supplied by the Company **PENTAIR WATER FRANCE S.A.S.** are warranted for a 5 years period from the date of shipment against faulty construction and/or defective materials, knowing that normal wear cannot be considered as a default i.e. items subject to wear under normal operating conditions of use (e.g. seals, pistons, brine valves, lights) are excluded of this warranty. Exceptions to this rule are: electronic boards, which are warranted for 18 months, and motors, which are warranted for 36 months from the manufacturing date indicated on the motor casing. This warranty is expressly limited to the replacement of defective parts without further compensation. The warranted parts, which the customer wants to be replaced, have to be returned in accordance with the RMA procedure. This warranty specifically excludes any liability consecutively to any damage that may be caused by parts or materials. This warranty specifically excludes faults due to negligence, improper control or maintenance or improper use of the product.

### Prices

All prices in the present price list:

- exclude VAT
- are in Euro
- include our standard packaging.

Unless explicitly agreed otherwise, all the vendor's prices are "ex-works". These are list prices, excluding taxes, charges, customs duties and all other duties that can be levied on the goods. Minimum order level is 250 € per order. Orders below 250 € could be exceptionally accepted but a participation to the administrative costs of 30 € per order will automatically be added to the invoice.

## PRODUITS FLECK - CONDITIONS DE GARANTIE

Le matériel vendu par la société **PENTAIR WATER FRANCE S.A.S.** est garanti pendant une durée de 5 ans à dater du jour de l'enlèvement contre tous vices de construction et/ou de matières premières, l'usure normale ne pouvant être considérée comme un vice : joints, pistons, vannes à saumure, voyants sont exclus de cette garantie. Font exception à cette règle les cartes électroniques, garanties 18 mois ; les moteurs, garantis 36 mois, mais à compter de la date du fabricant gravée sur le moteur. Cette garantie est exclusivement limitée à l'échange, sans indemnités des pièces reconnues défectueuses. Les pièces sous garantie dont le client demande le remplacement doivent être retournées conformément à la procédure de retour de pièces (RMA). La garantie est exclusive de toute responsabilité due à des accidents de personnes ou de choses ayant pu résulter de vices ou de défauts constatés. Elle ne pourra non plus s'étendre aux accidents provenant de négligence, défaut de surveillance ou d'entretien ou d'utilisation défectueuse de ce matériel.

### Prix

Tous les prix, objet de la liste de prix :

- sont stipulés hors taxes
- sont libellés en Euros
- incluent notre emballage standard.

Sauf accord explicite, tous les prix de vente sont "départ usine". Prix liste excluant les taxes, les charges, les frais de douane et tous autres frais pouvant être prélevés sur la marchandise. Montant minimum par commande : 250 €. Les commandes inférieures à 250 € pourront être acceptées à titre exceptionnel. En contrepartie, un montant supplémentaire de 30 € vous sera facturé pour participation aux frais administratifs.

## FLECK PRODUKTE - ALLGEMEINE GARANTIE

Die von der Firma **PENTAIR WATER FRANCE S.A.S.** vertriebenen Waren sind für eine Dauer von 5 Jahren, ab Versandtag vom Werk, gegen Fertigungs- und/oder Materialfehler garantiert. Die normale Abnutzung kann nicht als ein Mangel betrachtet werden. Die Teile wie z.B. O-Ringe, Kolben, Soleventile, Leuchten, die sich unter normaler Verwendung abnutzen, sind aus der Garantie ausgeschlossen. Ausnahmen zu dieser Regel sind Elektronikarten, die achtzehn (18) Monate lang garantiert sind, und Motoren, die sechsunddreißig (36) Monate lang garantiert sind. Bei Motoren läuft die Garantie ab dem Herstellerdatum, das auf dem Motorgehäuse steht. Diese Garantie beschränkt sich ausdrücklich auf Ersatzlieferungen ohne Entschädigung der als mangelhaft erkannten Teile. Die unter Garantie stehenden Teile, für die der Kunde den Ersatz verlangt, müssen unter Angabe der RMA Nummer an uns zurückgesandt werden. Die Garantie schließt jegliche Haftung für Schäden aus, die auf Teile oder Waren zurückzuführen sind. Sie kann auch nicht auf Unfälle durch Fahrlässigkeit, mangelnde Wartung oder Überwachung, oder mangelhafte Verwendung der Waren erweitert werden.

### Preise

Unsere Preise verstehen sich:

- ohne MwSt.
- in Euro
- inklusiv unsere Standard Verpackung.

Sofern keine andere Vereinbarung getroffen wurde, verstehen sich die Verkaufspreise "Ex works" (ab Werk, Buc, Frankreich) Die sind Listen Preise, ohne Steuer, Kosten, Zollgebühren und alle andere Steuer, die für Waren gelten. Mindestbestellbetrag soll 250 €/Bestellung sein. Bestellungen unter 250 € können ausnahmsweise angenommen werden, jedoch wird eine 30 € Beteiligung für die Abwicklungskosten automatisch berechnet.

**Warranty conditions for  
Pentair Water Europe products**



## WARRANTY CONDITIONS FOR PENTAIR WATER EUROPE PRODUCTS

### WARRANTIES AND LIABILITY OF THE SELLER

#### Introduction

In the present document the name Pentair Water Europe refers to the legal Entities producing, distributing and selling Pentair Water and outsourced products. In general none of the products made by Pentair Water Europe is a finished good meant to be sold directly to consumers. Pentair Water Europe manufactures, distributes and sells components mainly meant to be part of larger equipments, which are sold to commercial partners (i.e. distributors and/or OEMs). Exceptions to the above warranty conditions will be regulated by specific agreements. This warranty supersedes all previous publications.

#### Warranty Obligations granted by Pentair Water Europe

The products are guaranteed against defects arising from defective materials or workmanship for the following period starting from the day of shipment. Below the main product range manufactured or distributed by Pentair Water Europe. The warranty period refers to the most restrictive case within each product family (the warranty period relevant to each brand is stated in the specific warranty terms of the single brand):

- Valves (FLECK, SIATA): 5 years;
- Electronic boards (FLECK, SIATA): 18 months;
- Motors (FLECK, SIATA): 3 years;
- Valves, electronic boards, motors (AUTOTROL, AQUAMATIC): 5 years EXCEPT Magnum, 172, 180: 3 years & 480 Controllers: 1 year;
- Polyglass pressure vessels, composite pressure vessels, polyester vessels, expansion tanks (STRUCTURAL, WELLMATE): 5 years;
- Vinylester vessels, special vessels, distribution systems, spare parts, aircells (STRUCTURAL, WELLMATE): 2 years;
- Cabinets and brine tanks (PENTAIR PRODUCTS & ACCESSORIES): 2 years;
- Pumps (FLOTEC, NOCCHI, RIVER, SHURFLO): 1 year or more according to the type;
- Swimming pool automatic cleaners (LEGEND, NEW KREEPY KRAULY, E-Z VAC, KREEPY CADET, HOSES, LETRO SWEEP): 2 years or more according to the type;
- Underwater lightings for swimming pools (SAM, SAL, AQUALUMINATOR, AMERLITE, FIBERWORKS): 2 years;
- Swimming pool pumps (CHALLENGER, ULTRAFLOW, WHISPERFLOW, PINNACLE, HYDRONAUT, TRITON JET): 2 years or more according to the type;
- Swimming pool filters (TRITON, TAGELUS, NAUTILUS FNS, FNS PLUS, CLEAN&CLEAR PLUS, AZUF): 2 years or more according to the type;
- Swimming pool automatic sanitizers (AUTOMATIC FEEDER 300/320, COMMERCIAL FEEDER, SALT CHLORINATOR): 2 years or more according to the type;
- Swimming pool heating equipments (MINIMAX HEATPUMP): 2 years;
- Swimming pool controls (COMPOOL, INTELLI TOUCH): 2 years;
- Other filters, cartridges (PENTEK, EVERPURE, GE): 1 year or more according to the type;

Any other Pentair brand or family of product will be guaranteed by Pentair Water Europe no less than what is stated by the EU directive on this subject, by National laws and by commercial habits of Pentair. This warranty is limited to the repair or replacement of the defective parts or to the issue of a credit note for the amount invoiced to the Customers, if judged necessary by the Seller, without any further obligation whatsoever. The goods will be considered as being accepted if no written claim has been made by the Purchaser within 60 days from the receipt of the good. The warranty is granted to the initial Purchaser and will become void when the goods are transferred to a third party. The warranty is only valid provided that the goods are used in accordance with the purpose and with the limits they have been constructed for and proposed by the Seller to the Purchaser. The warranty is valid only if the goods are provided with their original label of identification with which they were shipped from Pentair locations. Should this not be available (removed, illegible) any arrangement will have to be discussed and agreed with your Pentair correspondent. Any irregular use of the goods will automatically cause the warranty to become void (as a partial and not complete example of the above one can state improper repackaging, improper shipping, misapplication, misuse, abuse, negligence, accidental damage, fire, acts of God or other circumstances outside the control of Pentair Water Europe). The Purchaser commits himself to take properly care of the goods, to respect the maintenance, to follow the guidelines of the Seller and to inform the Seller immediately of any defective part or any damage. In case of litigation, the applicable law as well as the competent Court will be the one of the Country where sits the Pentair Water Europe Company which has supplied the goods.

#### Warranties or Representations by Others

No dealer or other person has any authority to make any different warranties or representations concerning Pentair Water Europe Products. Accordingly, Pentair Water Europe nor any of its entities are to be held responsible for any such warranties or representation.

#### Return of the goods

No goods may be forwarded back to the Seller without the prior written authorization by the latter, so called **Return Material Authorization (RMA)**. This authorization does not imply any liability, whether direct or indirect, apparent or hidden, of the Seller and does not suspend in any event the payment owed by the Purchaser at the date they are due. Upon receipt of the written authorization by the Seller specifying also the address to which the defective item/s may be shipped, the Purchaser will send the item/s to the address indicated together with a copy of the RMA received by Pentair Water Europe. This need to be applied externally on the box or supplied with the shipping documents. In case of requests of RMA for returns of new, non defective material due to mistakes of Pentair Water Europe or of the Purchaser the RMA will have to be asked within 60 days from the receipt of the good and sent back within 30 days from the receipt of the RMA. In case of requests of RMA for returns of defective material (under or out of warranty) the RMA can be asked at any time and the item/s returned within 30 days as previously stated.

#### Freight costs

In case of new material to be returned to Pentair because of Customer's mistake, freight costs will be at customer's expense. In case of new material to be returned to Pentair because of Pentair's mistake, freight costs will be at Pentair's expense. In case of defective material under warranty to be returned to Pentair, freight costs will be at Pentair's expense both ways. In case of defective material out of warranty to be returned to Pentair, freight costs will be at Customer's expense both ways.

#### Other rights

This warranty gives you specific legal rights as above described. In addition, consumer's rights are protected where applicable, following European Directives or, in absence of, National laws.



## CONDITIONS DE GARANTIE DES PRODUITS PENTAIR WATER EUROPE

GARANTIES ET OBLIGATIONS DU VENDEUR

### Introduction

Dans ce document, le nom Pentair Water Europe se réfère aux Personnes Juridiques qui produisent, distribuent et vendent les produits Pentair Water ainsi que les produits exécutés par des tiers. Généralement, les produits Pentair Water Europe ne sont jamais des produits finis, prêts pour la vente directe au consommateur. Pentair Water Europe produit, distribue et vend essentiellement des composants à intégrer aux systèmes ou aux équipements plus importants, vendus à des partenaires commerciaux [par exemple aux distributeurs et/ou aux OEM (producteurs d'équipements originaux)]. Les éventuelles exceptions aux susdites conditions de garantie seront régies par des contrats spécifiques. Cette garantie remplace toutes les publications précédentes.

### Garanties offertes par Pentair Water Europe

Les produits sont garantis contre tous vices de construction et de matières premières pendant la période indiquée ci-dessous, à compter du jour de l'expédition. On reporte ci-après une liste des principaux produits fabriqués ou distribués par Pentair Water Europe. La période de garantie indiquée se réfère au cas plus limitatif dans chaque famille de produits (la période de garantie relative à chaque marque est indiquée dans les conditions de garantie spécifiques de chaque marque):

- Vannes de régulation (FLECK, SIATA) : 5 ans ;
- Cartes électroniques (FLECK, SIATA) : 18 mois ;
- Moteurs (FLECK, SIATA) : 3 ans ;
- Vannes de régulation, cartes électroniques, moteurs (AUTOTROL, AQUAMATIC) : 5 ans SAUF Magnum, 172, 180 : 3 ans & contrôleurs 480 : 1 an ;
- Bouteilles polyglass, bouteilles composites, bouteilles polyester, réservoirs d'expansion (STRUCTURAL, WELLMATE) : 5 ans ;
- Bouteilles vinylester, bouteilles spéciales, systèmes de distribution, pièces de rechange, vessies (STRUCTURAL, WELLMATE) : 2 ans ;
- Compacts et bacs à sel (PENTAIR PRODUCTS & ACCESSORIES) : 2 ans ;
- Pompes (FLOTEC, NOCCHI, RIVER, SHURFLO) : 1 an ou plus, selon le modèle ;
- Nettoyeurs automatiques pour piscines (LEGEND, NEW KREEPY KRAULY, E-Z VAC, KREEPY CADET, HOSES, LETRO SWEEP) : 2 ans ou plus, selon le modèle ;
- Eclairage sous-marin pour piscines (SAM, SAL, AQUALUMINATOR, AMERLITE, FIBERWORKS) : 2 ans ;
- Pompes pour piscines (CHALLENGER, ULTRAFLOW, WHISPERFLOW, PINNACLE, HYDRAUNAUT, TRITON JET) : 2 ans ou plus, selon le modèle ;
- Filtres pour piscines (TRITON, TAGELUS, NAUTILUS FNS, FNS PLUS, CLEAN&CLEAR PLUS, AZUR) : 2 ans ou plus, selon le modèle ;
- Produits pour le traitement automatique de l'eau des piscines (DOSEUR AUTOMATIQUE DE CHLORE 300/200, DOSEUR AUTOMATIQUE DE CHLORE À CAPACITÉ ÉLEVÉE, SYSTÈME DE PRODUCTION ÉLECTROLYTIQUE DE CHLORE) : 2 ans ou plus, selon le modèle ;
- Système de chauffage pour piscines (POMPE À CHALEUR MINIMAX) : 2 ans ;
- Commandes pour piscines (COMPOOL, INTELLI TOUCH) : 2 ans ;
- Autres filtres, cartouches (PENTEK, EVERPURE, GE) : 1 an ou plus, selon le modèle.

Toute autre marque ou famille de produits Pentair sera garantie au minimum par Pentair Water Europe sur la base de ce qui est prévu par la directive européenne en vigueur en la matière, selon les lois nationales et la pratique commerciale de Pentair. Cette garantie se limite à la réparation ou au remplacement des parties défectueuses ou à l'émission d'une note de crédit du montant facturé au client, si cela est jugé nécessaire par le vendeur, sans aucune autre obligation. La marchandise sera considérée comme acceptée si l'Acheteur n'envoie aucune réclamation écrite dans un délai maximum de 60 jours à compter de la réception de la marchandise. La garantie est valable vis-à-vis du premier Acheteur et devient nulle si la marchandise est transférée à un tiers. La garantie est uniquement valable si la marchandise est utilisée selon l'emploi prévu et dans les limites pour lesquelles elle a été construite et proposée par le Vendeur à l'Acheteur. La garantie est uniquement valable si la marchandise est fournie avec son étiquette d'identification originale, avec laquelle elle a été expédiée par les sites de Pentair. Si cette étiquette n'est pas présente, (enlevée ou illisible), des accords spécifiques devront être pris avec le correspondant Pentair. Toute utilisation impropre de la marchandise provoque automatiquement l'annulation de la garantie (à titre d'exemple mais non limitatif, en cas de réemballage inapproprié, d'expédition inadéquate, d'application erronée, d'utilisation impropre, d'abus, de négligence, d'endommagement accidentel, d'incendie, de causes de force majeure ou autres circonstances indépendantes de la volonté de Pentair Water Europe). L'Acheteur s'engage à prendre en charge la marchandise de manière appropriée, à respecter les instructions relatives à l'entretien, à suivre les instructions du Vendeur et à informer immédiatement le Vendeur de toute partie défectueuse ou d'un quelconque endommagement. En cas de conflit, la législation en vigueur et le Tribunal compétent seront ceux du pays dans lequel se trouve la filiale Pentair Water Europe qui a fourni la marchandise.

### Garanties ou déclarations d'autres personnes

Aucun concessionnaire ou autre personne n'a le pouvoir d'accorder des garanties différentes ou de faire des déclarations différentes pour les produits Pentair Water Europe. Par conséquent, ni Pentair Water Europe, ni aucune de ses filiales ne peuvent être considérées responsables des garanties ou des déclarations différentes.

### Renvoi de la marchandise

La marchandise ne peut pas être réexpédiée au Vendeur sans son autorisation préalable écrite ainsi que l'**Autorisation de Retour de Matériel (RMA)**. Cette autorisation n'implique aucune responsabilité, ni directe ni indirecte, apparente ou cachée, de la part du Vendeur et n'interrompt en aucun cas les paiements à la charge de l'Acheteur, valables à leurs dates d'échéance. Lors de la réception de l'autorisation écrite de la part du Vendeur avec laquelle on précise également l'adresse à laquelle il faut envoyer l'article ou les articles défectueux, l'Acheteur enverra les articles à l'adresse indiquée ainsi qu'une photocopie du RMA reçu par Pentair Water Europe. Ce document doit être appliqué sur l'extérieur de la boîte ou fourni avec les documents d'expédition. En cas de demandes de RMA pour retourner du matériel neuf non défectueux suite à des erreurs commises par Pentair Water Europe ou par l'Acheteur, le RMA devra être demandé dans un délai de 60 jours à compter de la réception de la marchandise et réexpédié avant 30 jours à compter de la réception du RMA. En cas de demandes de RMA pour retourner du matériel défectueux (sous garantie ou non) le RMA peut être demandé à tout moment et les articles peuvent être retournés dans un délai de 30 jours comme indiqué ci-dessus.

### Frais d'expédition

En cas de nouveaux matériels à retourner à Pentair suite à une erreur de la part du Client, les frais d'expédition seront à la charge du Client. En cas de nouveaux matériels à retourner à Pentair suite à une erreur de la part de Pentair, les frais d'expédition seront à la charge de Pentair. En cas de matériels défectueux sous garantie à retourner à Pentair, les frais d'expédition seront à la charge de Pentair (aller et retour). En cas de matériels défectueux hors garantie à retourner à Pentair, les frais d'expédition seront à la charge du client (aller et retour).

### Autres droits

Cette garantie accorde au consommateur les droits légaux spécifiques décrits ci-dessus. De plus, les droits du consommateur sont protégés, là où ils sont en vigueur, selon ce qui est prévu par les Directives Européennes ou en leur absence, par les lois nationales.



# Pentair Water in Europe



**Pentair Water Belgium n.v.**

**Pentair Water Italy S.r.l.**

**Pentair Water in Spain**

**Pentair Water France SAS**

**Pentair Water Middle-East**

**Pentair Water in Turkey**

**Pentair Water in Germany**

**Pentair Water in Russia**

**Pentair Water in UK**

**Pentair Water South Africa Pty, Ltd.**

**Information**

**[www.pentairaqua.com](http://www.pentairaqua.com)**